



STS12NF30L

N - CHANNEL 30V - 0.0085Ω - 12A SO-8 STripFET™ POWER MOSFET

TYPE	V _{DSS}	R _{DS(on)}	I _D
STS12NF30L	30 V	< 0.01 Ω	12 A

- TYPICAL R_{DS(on)} = 0.0085 Ω
- STANDARD OUTLINE FOR EASY AUTOMATED SURFACE MOUNT ASSEMBLY
- LOW THRESHOLD DRIVE

DESCRIPTION

This Power MOSFET is the second generation of STMicroelectronics unique "Single Feature Size™" strip-based process. The resulting transistor shows extremely high packing density for low on-resistance, rugged avalanche characteristics and less critical alignment steps therefore a remarkable manufacturing reproducibility.

APPLICATIONS

- DC MOTOR DRIVE
- DC-DC CONVERTERS
- BATTERY MANAGEMENT IN NOMADIC EQUIPMENT
- POWER MANAGEMENT IN PORTABLE/DESKTOP PC_s

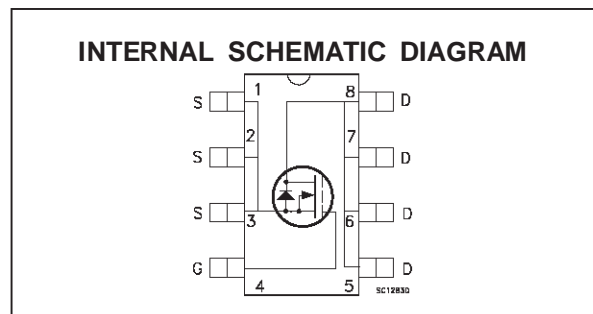
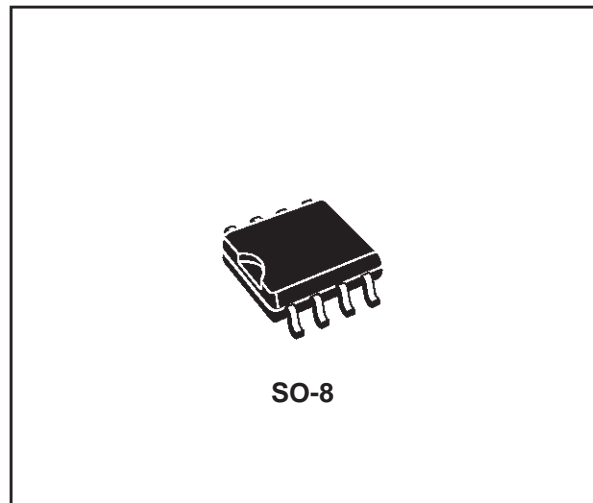

ABSOLUTE MAXIMUM RATINGS

Symbol	Parameter	Value	Unit
V _{DS}	Drain-source Voltage (V _{GS} = 0)	30	V
V _{DGR}	Drain- gate Voltage (R _{GS} = 20 kΩ)	30	V
V _{GS}	Gate-source Voltage	± 20	V
I _D	Drain Current (continuous) at T _c = 25 °C Drain Current (continuous) at T _c = 100 °C	12 7.5	A A
I _{DM} (•)	Drain Current (pulsed)	48	A
P _{tot}	Total Dissipation at T _c = 25 °C	2.5	W

(•) Pulse width limited by safe operating area

STS12NF30L

THERMAL DATA

R _{thj-amb} T _j T _{stg}	(*)Thermal Resistance Junction-ambient Maximum Operating Junction Temperature Storage Temperature	50 150 -55 to 150	°C/W °C °C
--	---	-------------------------	------------------

(*) Mounted on FR-4 board (t ≤ 10sec)

ELECTRICAL CHARACTERISTICS (T_{case} = 25 °C unless otherwise specified)

OFF

Symbol	Parameter	Test Conditions	Min.	Typ.	Max.	Unit
V _{(BR)DSS}	Drain-source Breakdown Voltage	I _D = 250 μA V _{GS} = 0	30			V
I _{DSS}	Zero Gate Voltage Drain Current (V _{GS} = 0)	V _{DS} = Max Rating V _{DS} = Max Rating T _c = 125 °C			1 10	μA μA
I _{GSS}	Gate-body Leakage Current (V _{DS} = 0)	V _{GS} = ± 20 V			± 100	nA

ON (*)

Symbol	Parameter	Test Conditions	Min.	Typ.	Max.	Unit
V _{GS(th)}	Gate Threshold Voltage	V _{DS} = V _{GS} I _D = 250 μA	1	1.6	2.5	V
R _{DS(on)}	Static Drain-source On Resistance	V _{GS} = 10 V I _D = 6 A V _{GS} = 4.5 V I _D = 6 A		0.0085 0.01	0.01 0.012	Ω Ω
I _{D(on)}	On State Drain Current	V _{DS} > I _{D(on)} × R _{DS(on)max} V _{GS} = 10 V	12			A

DYNAMIC

Symbol	Parameter	Test Conditions	Min.	Typ.	Max.	Unit
g _{fs} (*)	Forward Transconductance	V _{DS} > I _{D(on)} × R _{DS(on)max} I _D = 6 A		20		S
C _{iss} C _{oss} C _{rss}	Input Capacitance Output Capacitance Reverse Transfer Capacitance	V _{DS} = 25 V f = 1 MHz V _{GS} = 0 V		2400 590 200		pF pF pF

ELECTRICAL CHARACTERISTICS (continued)

SWITCHING ON

Symbol	Parameter	Test Conditions	Min.	Typ.	Max.	Unit
$t_{d(on)}$	Turn-on Delay Time	$V_{DD} = 15\text{ V}$ $I_D = 6\text{ A}$ $R_G = 4.7\ \Omega$ $V_{GS} = 4.5\text{ V}$ (Resistive Load, see fig. 3)		35		ns
t_r	Rise Time			90		ns
Q_g	Total Gate Charge	$V_{DD} = 24\text{ V}$ $I_D = 12\text{ A}$ $V_{GS} = 4.5\text{ V}$		35	50	nC
Q_{gs}	Gate-Source Charge			9		nC
Q_{gd}	Gate-Drain Charge			18		nC

SWITCHING OFF

Symbol	Parameter	Test Conditions	Min.	Typ.	Max.	Unit
$t_{d(off)}$	Turn-off Delay Time	$V_{DD} = 15\text{ V}$ $I_D = 6\text{ A}$ $R_G = 4.7\ \Omega$ $V_{GS} = 4.5\text{ V}$ (Resistive Load, see fig. 3)		90		ns
t_f	Fall Time			45		ns
$t_{r(Voff)}$	Off-voltage Rise Time	$V_{clamp} = 24\text{ V}$ $I_D = 12\text{ A}$ $R_G = 4.7\ \Omega$ $V_{GS} = 4.5\text{ V}$ (Inductive Load, see fig. 5)		35		ns
t_f	Fall Time			35		ns
t_c	Cross-over Time			80		ns

SOURCE DRAIN DIODE

Symbol	Parameter	Test Conditions	Min.	Typ.	Max.	Unit
I_{SD}	Source-drain Current				12	A
$I_{SDM}(\bullet)$	Source-drain Current (pulsed)				48	A
$V_{SD}(\ast)$	Forward On Voltage	$I_{SD} = 12\text{ A}$ $V_{GS} = 0$			1.2	V
t_{rr}	Reverse Recovery Time	$I_{SD} = 12\text{ A}$ $di/dt = 100\text{ A}/\mu\text{s}$ $V_{DD} = 15\text{ V}$ $T_j = 150\text{ }^\circ\text{C}$ (see test circuit, fig. 5)		45		ns
Q_{rr}	Reverse Recovery Charge			70		nC
I_{RRM}	Reverse Recovery Current			3		A

(*) Pulsed: Pulse duration = 300 μs , duty cycle 1.5 %

(•) Pulse width limited by safe operating area

Safe Operating Area

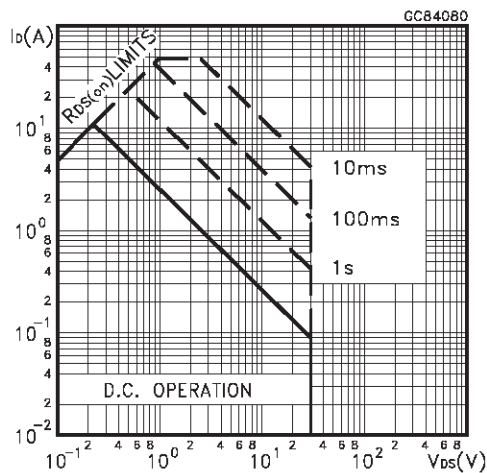

Thermal Impedance

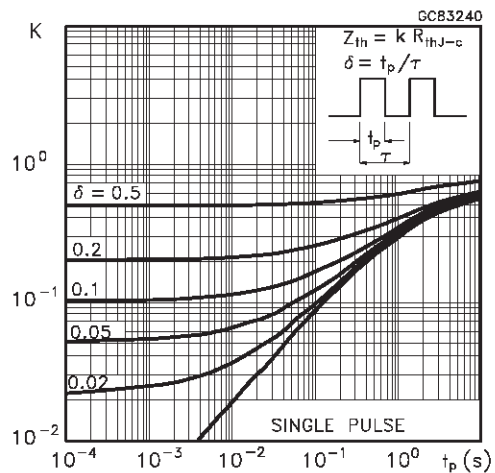

Output Characteristics

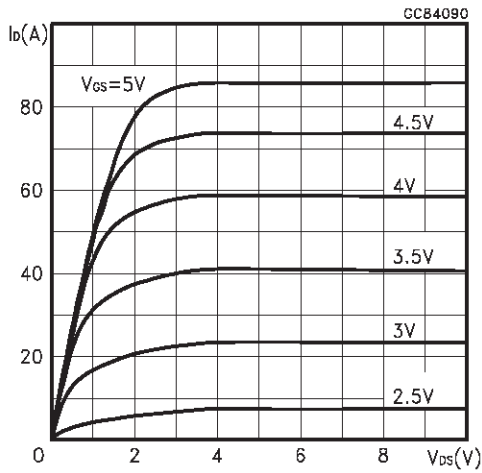

Transfer Characteristics

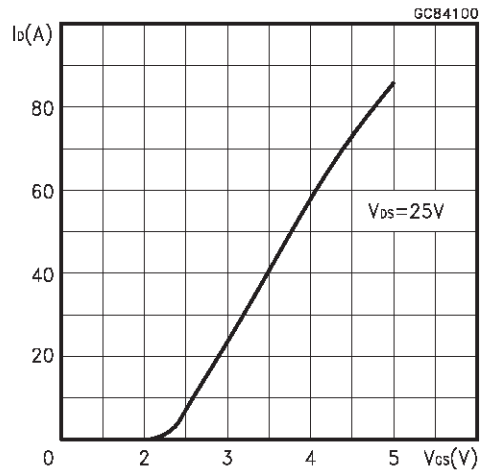

Transconductance

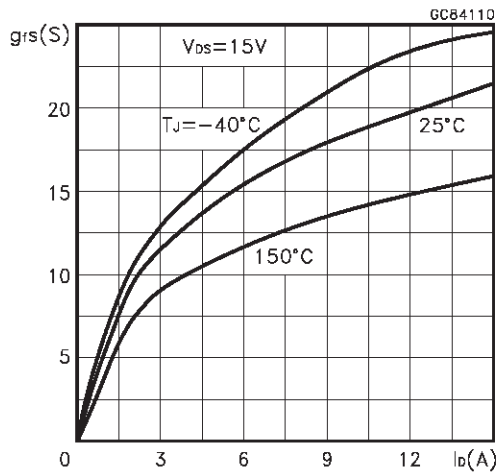

Static Drain-source On Resistance

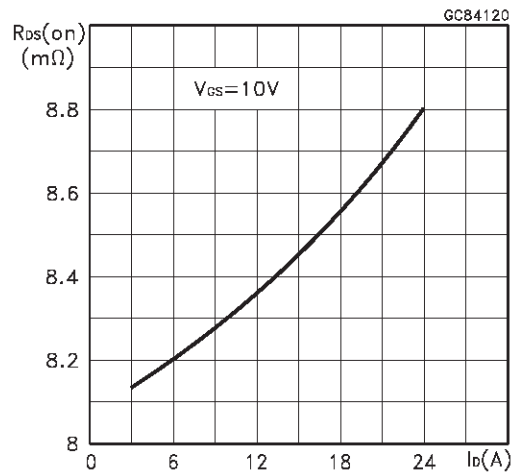

Gate Charge vs Gate-source Voltage

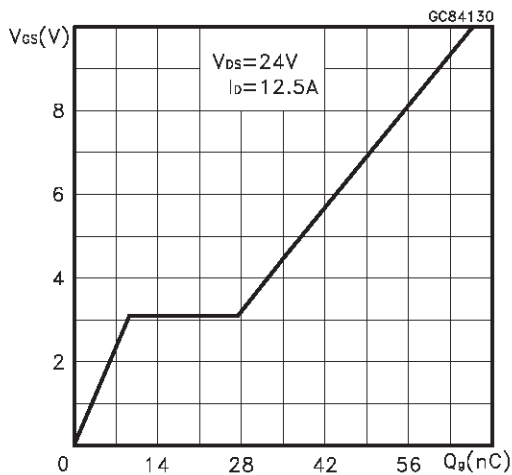

Capacitance Variations

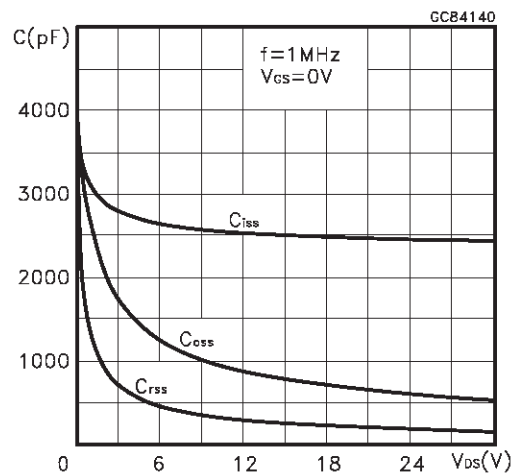

Normalized Gate Threshold Voltage vs Temperature

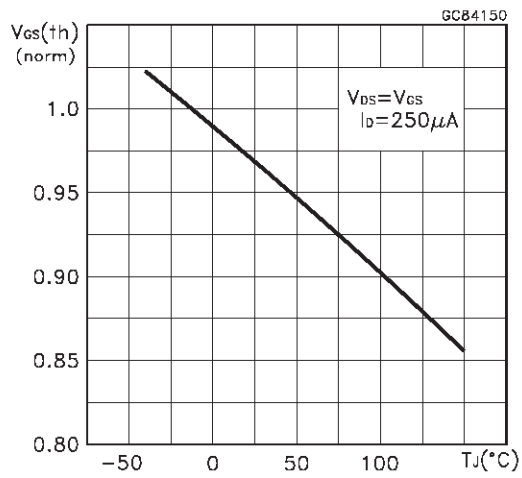

Normalized On Resistance vs Temperature

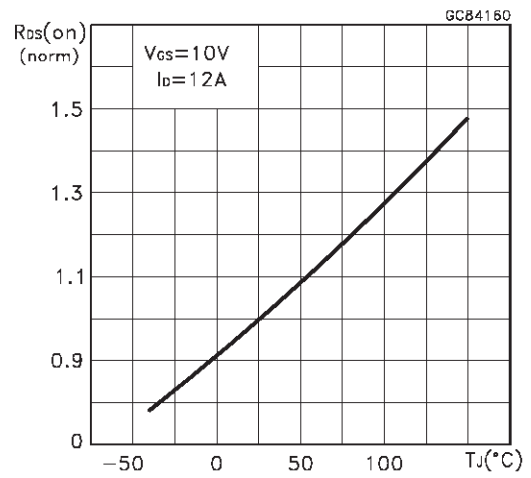

Source-drain Diode Forward Characteristics

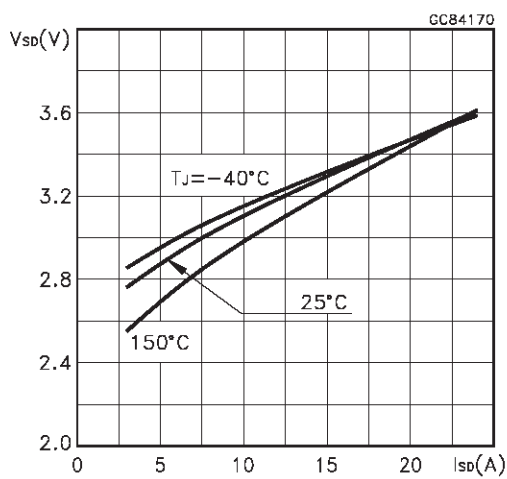

Fig. 1: Unclamped Inductive Load Test Circuit



Fig. 2: Unclamped Inductive Waveform



Fig. 3: Switching Times Test Circuits For Resistive Load



Fig. 4: Gate Charge test Circuit

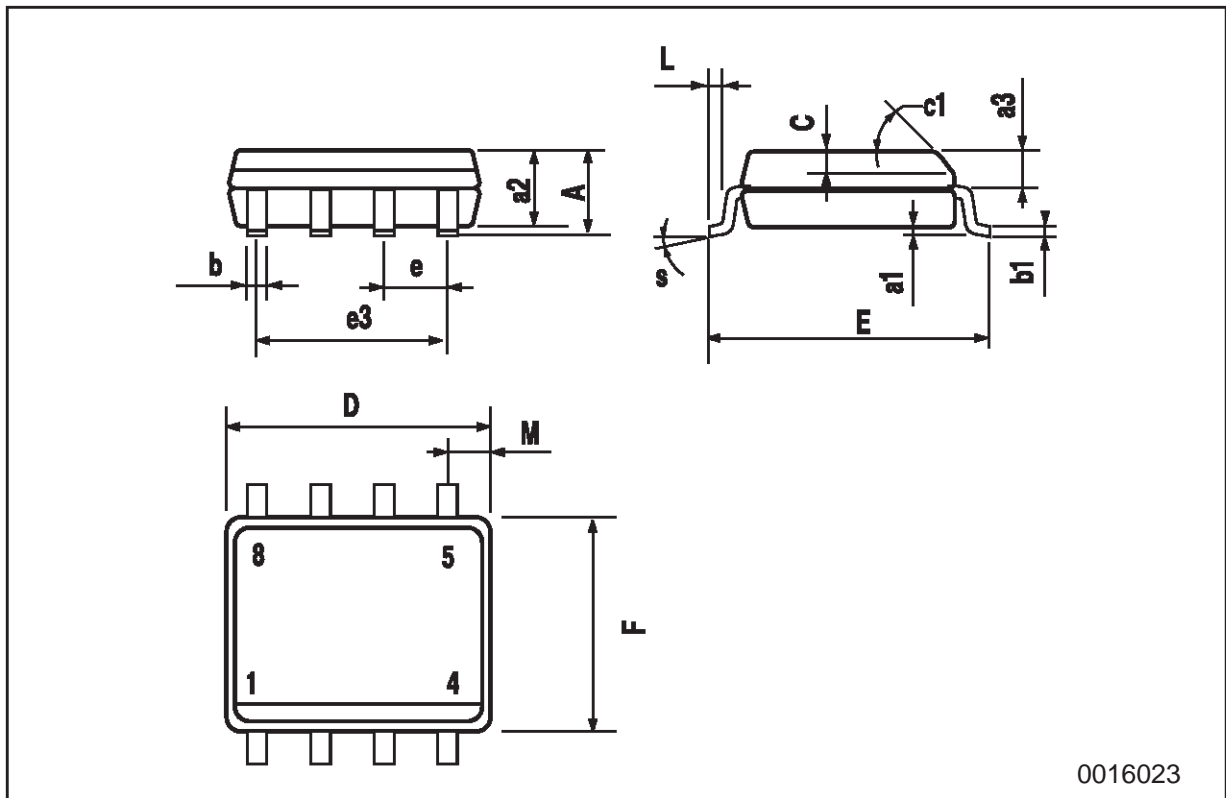

Fig. 5: Test Circuit For Inductive Load Switching And Diode Recovery Times



SO-8 MECHANICAL DATA

DIM.	mm			inch		
	MIN.	TYP.	MAX.	MIN.	TYP.	MAX.
A			1.75			0.068
a1	0.1		0.25	0.003		0.009
a2			1.65			0.064
a3	0.65		0.85	0.025		0.033
b	0.35		0.48	0.013		0.018
b1	0.19		0.25	0.007		0.010
C	0.25		0.5	0.010		0.019
c1	45 (typ.)					
D	4.8		5.0	0.188		0.196
E	5.8		6.2	0.228		0.244
e		1.27			0.050	
e3		3.81			0.150	
F	3.8		4.0	0.14		0.157
L	0.4		1.27	0.015		0.050
M			0.6			0.023
S	8 (max.)					



0016023

Information furnished is believed to be accurate and reliable. However, STMicroelectronics assumes no responsibility for the consequences of use of such information nor for any infringement of patents or other rights of third parties which may result from its use. No license is granted by implication or otherwise under any patent or patent rights of STMicroelectronics. Specification mentioned in this publication are subject to change without notice. This publication supersedes and replaces all information previously supplied. STMicroelectronics products are not authorized for use as critical components in life support devices or systems without express written approval of STMicroelectronics.

The ST logo is a trademark of STMicroelectronics

© 1999 STMicroelectronics – Printed in Italy – All Rights Reserved
STMicroelectronics GROUP OF COMPANIES

Australia - Brazil - Canada - China - France - Germany - Italy - Japan - Korea - Malaysia - Malta - Mexico - Morocco - The Netherlands - Singapore - Spain - Sweden - Switzerland - Taiwan - Thailand - United Kingdom - U.S.A.